

B-B

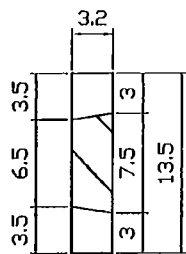

C-C

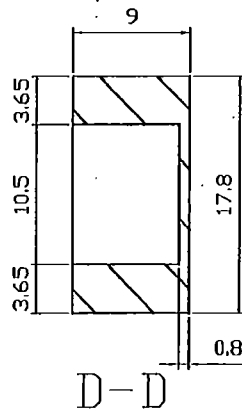

D-D

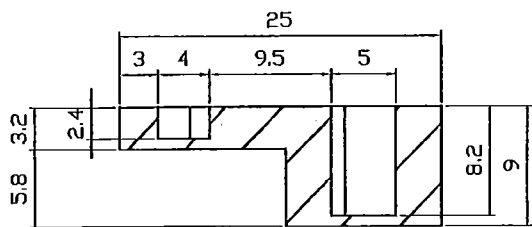

A-A

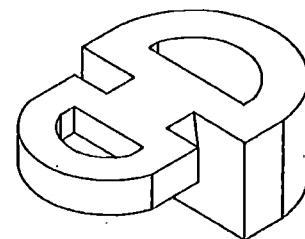
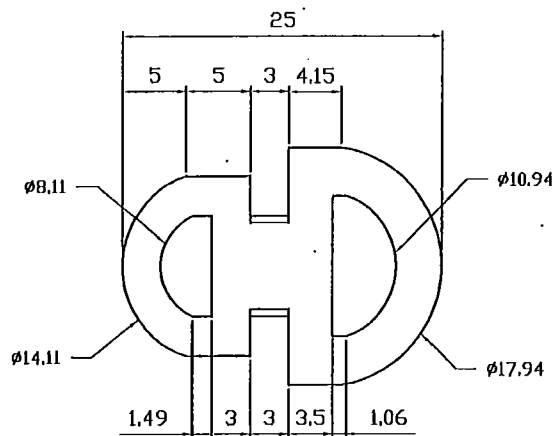



**巨薪企業股份有限公司**  
 台中市太平區工業15路42號  
 TEL: (04)22715311 FAX: (04)22715312

客戶	巨薪
圖名	消音塊
圖號	1001243
日期	100.12.13
客戶圖號	
備註	

1. 去銳角R2 2. 表面請勿刮傷

變更日期	變更內容
------	------

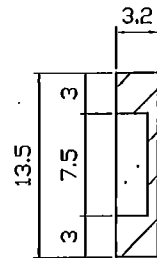
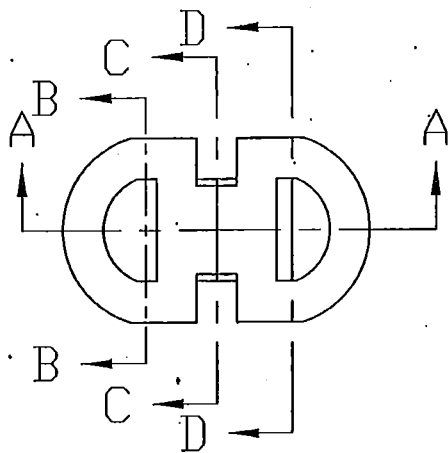
核准	校對	製圖
		Liang



B-B

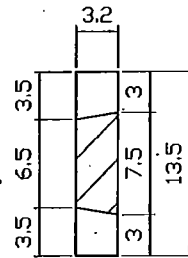

C-C

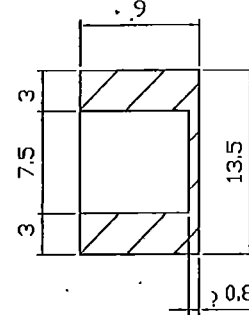

D-D

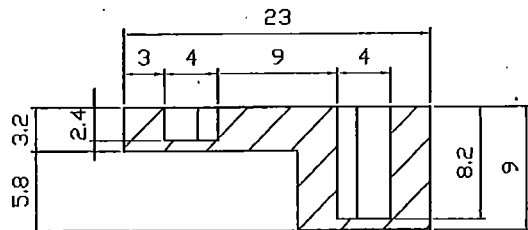
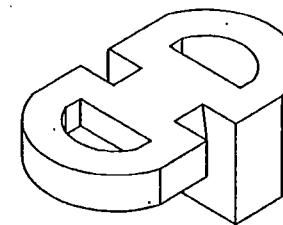

A-A

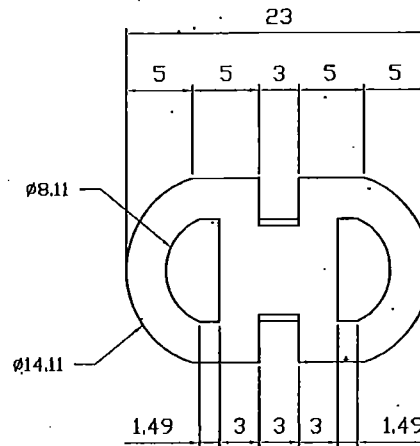

1. 去銳角R2 2. 表面請勿刮傷

 <b>巨薪企業股份有限公司</b> 台中市太平區工業15路42號 TEL:(04)22715311 FAX:(04)22715312 <small>機械配件</small>			客戶	巨薪	
			圖名	消音塊	
核准		校對	製圖	圖號	1001243-1(一樣大)
變更日期		變更內容		日期	103.08.01
				客戶圖號	
				備註	